

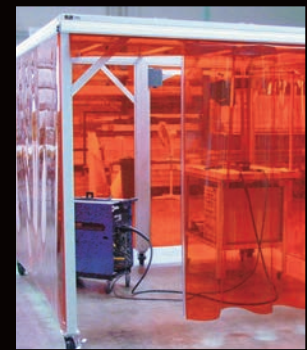

SIS-212 Modular Frame System

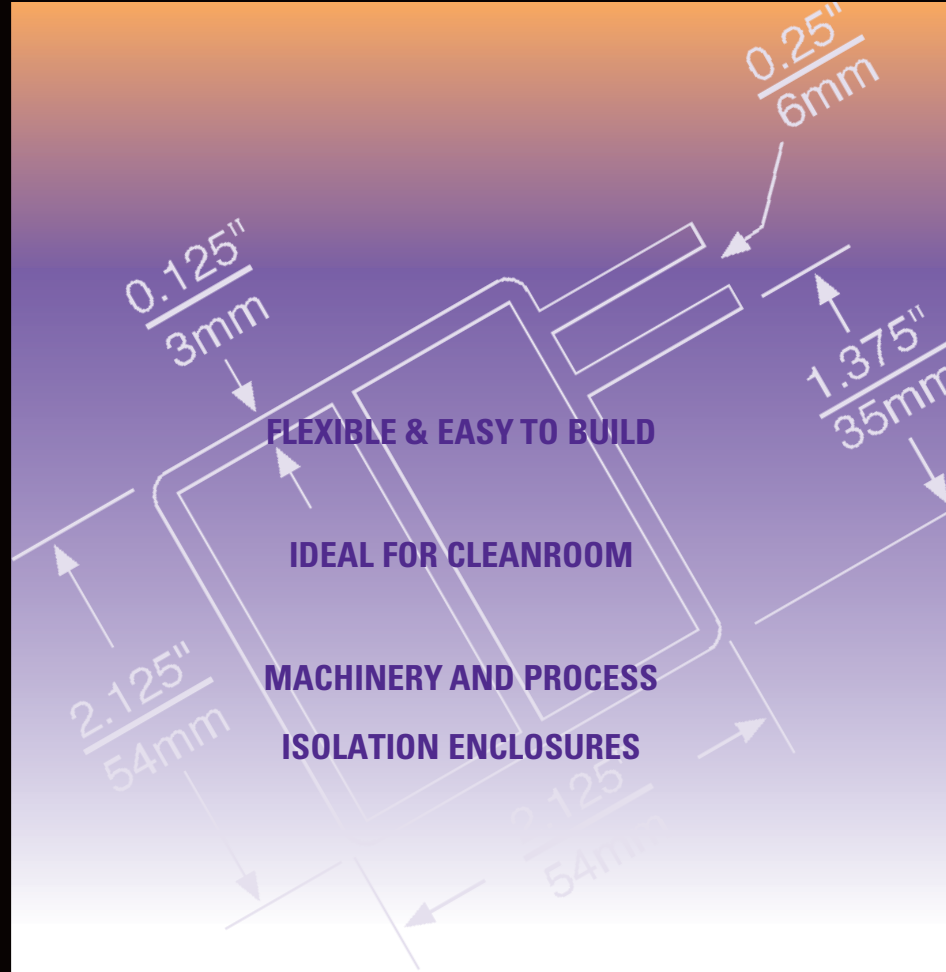

SIMPLEX
ISOLATION SYSTEMS™



Expect a Full Measure of Quality.



The **Simplex SIS-212 Modular Frame System** provides a wide variety of enclosure solutions for cleanrooms, dust control, sound control, safety and other industrial applications. The system is **designed for fast construction** and can be easily customized. Enclosures can be fitted with HEPA filters and modular air conditioning units, or can be quickly adapted to existing ventilating and dust collection systems.

- **Heavy-duty 2-1/8" x 2-1/8" anodized aluminum extrusion framework.**
- **Basic extrusion used to build all types of structures, from simple machinery isolation frames to cleanroom enclosures.**
- **Choice of Compression Latch or Bolt Together designs, both ensure a strong structural connection.**
- **Available with Simplex AirLock™ ceiling modules with integrated, fully gasketed 2" T-Grid.**
- **Knock-in corners for easy assembly.**
- **Easy to customize to fit any application.**
- **Choice of pre-fabricated enclosures or bulk material to build your own enclosures.**



One Extrusion Does It All



One Extrusion Does It All

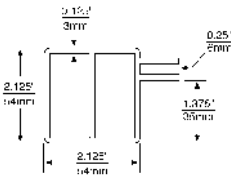

The Simplex **SIS Modular Frame System** is built around simple, strong, easy to assemble modules. You can quickly assemble three or four sided modular sections and latch or screw them together. It's that simple! Modules can be easily disassembled or expanded as your needs change.

Wall Materials & Doors

Wall Materials and Installation Options

FULL LINE OF CURTAIN SYSTEMS

Strip Doors, solid softwalls, and bi-folding curtains. Anti-static, laser, welding, sound control and non-outgassing ESD curtains available.

RIGID PANEL INSERTS

Most industrial panels are available, aluminum composites, acrylic, polycarbonate, ABS, and PVC. Frame accepts 1/8" or 1/4" thick material between rails or surface mount up to 1 3/8" thick.

Door Options and Accessories

Swinging doors, sliding doors, single and double, ABS or clear impact doors, flexible panel doors and pass throughs.

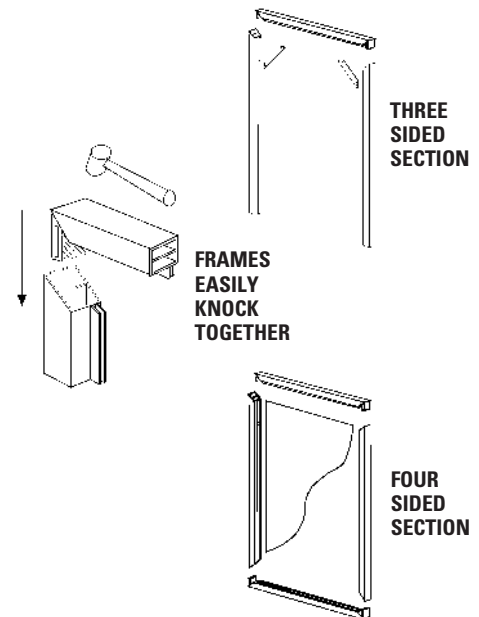

CEILING SYSTEM, SUPPORT OPTIONS & ATTACHMENTS



SIS Ceiling Modules

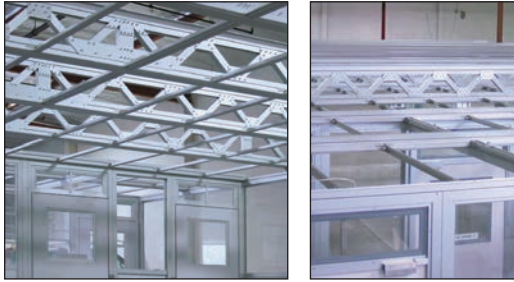

The standard SIS Framework modular ceiling structure can accommodate a variety of ceiling loads from light to heavy. The module frame components are structurally designed for easy assembly and able to adapt to various room configurations.

The standard SIS Framework ceiling is a fully integrated 2" T-bar. When assembling pre-fabricated modules, simply set the ceiling assembly onto the room and fasten it down. Ceiling accepts standard 2' x 4' ceiling tiles and components such as HEPAs and lights. Ceiling options include all-vinyl ceilings in both clear and colored materials.

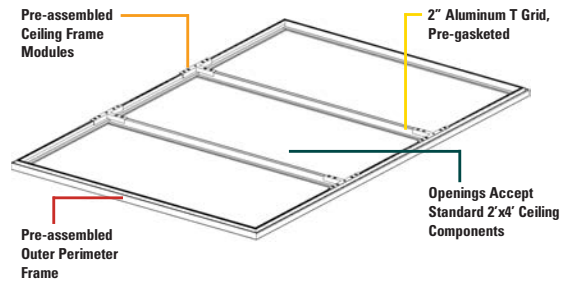

Ceiling Support Options

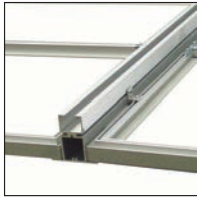

Medium-duty aluminum support struts measuring 2" x 4" are integrated between ceiling panels for room widths up to 16 feet wide with limited ceiling loads.

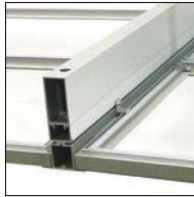

Stiffeners can be added to aluminum struts measuring 2" x 4" to accommodate larger rooms up to 18 feet wide with larger ceiling loads.

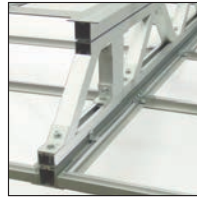

Heavy-duty truss systems can be added to standard struts to accommodate spans up to 21 feet wide and heavier ceiling loads.

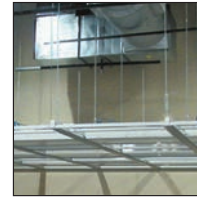

Threaded rod suspenders support ceiling frames or struts from any existing structure above for larger rooms of any size. Ceiling loads are limited only by the number of attachments and the strength of the existing ceiling.



Ceiling to Strut Connector is used to connect existing ceiling frames to standard struts.

Floor, Wall & Ceiling Attachment Hardware Options



Floor Cleats
2" x 2" x 41/4" Aluminum cleats are used at all joints.



Flush Mount For Wall, Floor And Ceiling
2" x 2" Aluminum angle with corner plate gives clean look and allows for up to 1" adjustment.



Single Or Double Angle
2" x 2" Aluminum angle used for wall, floor or ceiling attachment.

With SIS Framing you have many options for venting. The three shown are the most popular.

SIS WALL PANEL VENTING OPTIONS



Louvered Grill



Sliding Adjustable ABS Air Grill

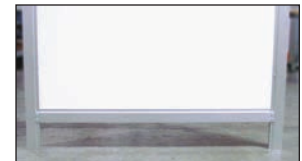

Open Air Space

Also available are cut-outs for duct collars and air change panels for recirculating systems.

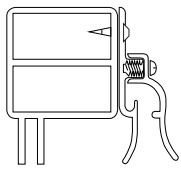

Typical softwall attachment with Simplex Hook Bead mounting bar.

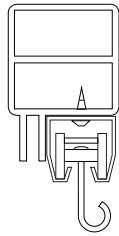

Typical sliding curtain track and roller attachment.

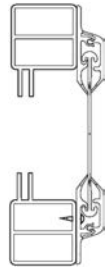

Softwall attachment with Simplex Flextrack Mounting top and bottom.

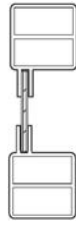

Double-channel supports many different hardwall materials.

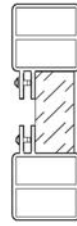

Attachment for insulated core panel up to 1.375" thick.

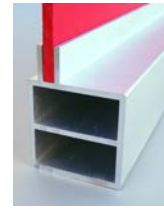

1/4" Insert



1/8" Insert with Glazing



Slot Cap PVC Grey



Floor Cleats secure cleanroom structures firmly to the floor and ensure a proper seal.



Aluminum corner insert for fast assembly.



Corner tube gussets available in varying lengths.



Casters are available to make enclosures portable.



Leg leveller can be used for uneven floors or critical placement of rooms.



Leg sections connect with internal screw and are finished with chrome cap.

Typical Applications



ISOLATION ENCLOSURES



MACHINERY AND WELDING ENCLOSURES



CUSTOM ENVIRONMENTAL ENCLOSURES



WALL SYSTEMS AND PARTITIONS



Simplex Strip Doors, LLC.
14500 Miller Ave.
Fontana, CA 92336
Toll Free: **800 854-7951**
FAX: **909 429-0217**

website: simplexisolationssystem.com
e-mail: sales@simplexis.net

Distributed By